









## ADDITIONAL EQUIPMENT RENTAL AND STAND CONSTRUCTION

### *Information material and price list*

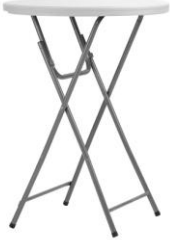
*This material includes the most commonly rented stand equipment and furniture for exhibition participants. If you cannot find the item you need, please contact the Exhibition Office - we will try to provide a suitable solution.*

#### #1.1: Table and chair rental - for both outdoor and indoor stand use



		
<p><b>Small round table</b> (d =81.3, h=74.3cm, light grey) – 11.00 EUR + VAT.</p> <p><b>Tablecloth for round table</b> (d=210 cm, white) – 15.00 EUR + VAT.</p>	<p><b>Large round table</b> (d=122, h=74.3cm, light grey) – 12.00 EUR + VAT.</p> <p><b>Tablecloth for round table</b> (d=210 cm, white) – 15.00 EUR + VAT.</p>	<p><b>Squared table</b> (182.9x75.2, h=74.3cm, light grey) – 13.00 EUR + VAT.</p> <p><b>Tablecloth</b> (154x245cm, white) – 15.00 EUR + VAT.</p>
		
<p><b>Bar type table</b> (d=81.3, h=110 cm, light grey) – 13.00 EUR + VAT.</p>	<p><b>Elastic tablecloth for bar type table:</b> white, grey, black or red –15.00 EUR + VAT.</p>	
		
<p><b>Folding chair</b> (47x55.6, h=84cm, light grey), 6.00 EUR + VAT.</p>	<p><b>Banquet type chair</b> (44x46, h=93cm, black with brown dots), 8.00 EUR + VAT.</p>	<p><b>Bar type chair</b> (35x35, h=94cm, black surface), 9.00 EUR + VAT.</p>

## #1.2: Table and chair rental - for indoor stand use only



		
<p><b>Squared table</b> (80x80cm, h=75 cm), 56.00 EUR + VAT.</p>	<p><b>Bar type chair</b> (35x35, h=94cm, white, black or dark gray surface), 26.00 EUR + VAT.</p>	<p><b>Banquet type chair</b> (38x40, h =96cm, white surface), 26.00 EUR + VAT.</p>

## #2.1: Standard built stand in the hall — visual examples

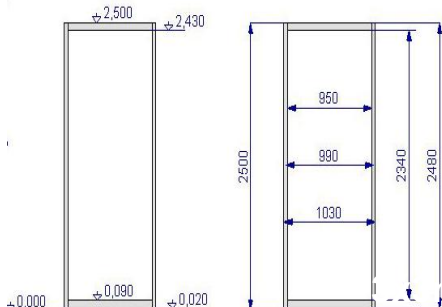

and options for creating an individual visual identity (furnishing is up to exhibitor).

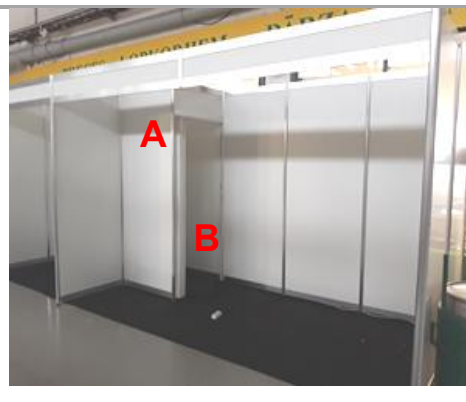

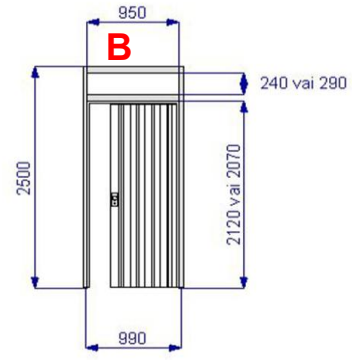
 <p style="text-align: right;"><b>3x5m</b></p>	 <p style="text-align: right;"><b>3x3m</b></p>	
<p><b>Equipped stand with 2 open sides. With CORNICE in front of the stand.</b></p> <p>15 sq.m. (5 m wide; 3 m deep). Standard construction performed by the organizer – grey carpet (15 sq.m), standard walls and creation of stand constructions (8 m) and cornice (8 m), provision of stand lighting (5 pcs.) and electrical connection (220V, up to 2kW) with socket.</p>	<p><b>Equipped stand with 1 open sides. With CORNICE.</b></p> <p>9 sq.m (3 m wide; 3 m deep). Standard construction performed by the organizer – grey carpet (9 sq.m), standard walls and creation of stand constructions (9 m) and cornice (3 m), provision of stand lighting (3 pcs.) and electrical connection (220V, līdz 2kW) with socket.</p>	<p><b>Wall construction parameters.</b></p> <p>Height of white panels with construction - 2,500 mm Visible white part: 950 mm The total size of the panel and construction - 1030 mm.</p>

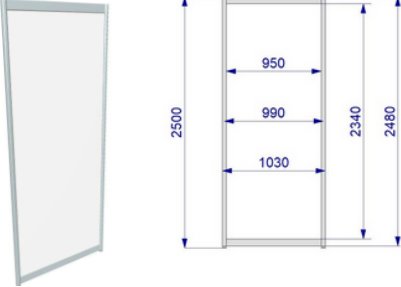

## #2.3: Construction of a lockable room in the stand. Example with room of 1x1m



		
<p><b>Above you can see a room with area of 1x1m. It is made from 1 standard wall panel and 1 block with sliding doors.</b> The area (size) and configuration of the lockable room can be adapted to your needs!</p> <p><b>A) Wall panel (250x100) (including the construction of the frame structure) – 26.00 EUR + VAT.</b> <b>B) Sliding door block (including frame construction) – 41.00 EUR + VAT.</b></p>		

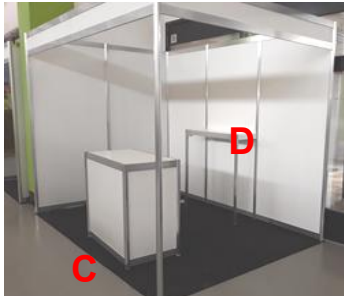

## #2.4: Stand setup equipment and furniture from modular stand systems.

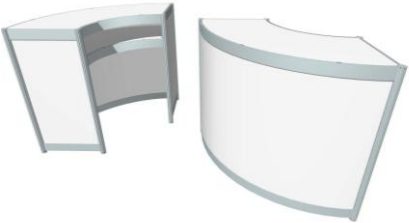

 <p><b>A</b></p>		 <p><b>B</b></p>
<p><b>Wall panel (250x100)</b> (including the construction of the frame structure), 26.00 EUR + VAT.</p> <p><b>Wall panel (250x50)</b> (including the construction of the frame structure), 20.00 EUR + VAT.</p>	<p><b>Mounting of one wall-block constructions</b> (without panel), 21.00 EUR + VAT.</p>	<p><b>Wall-block with sliding doors</b> (including mounting of panel constructions), 41.00 EUR + VAT.</p> <p><b>Wall-block with hinged doors</b> (including mounting of panel constructions), 56.00 EUR + VAT.</p>

 <p><b>D</b></p>		
<p><b>Built-in shelf, for example for placing TV,</b> (100x30x120), 30.00 EUR + VAT. (h=120, max 30kg, wall-block is not included in the price).</p>	<p><b>Built-in shelf (30x100),</b> 15.00 EUR + VAT (per 1 shelf, h = optional, max 10kg, wall-block is not included in the price).</p>	<p><b>Circular wall block (250x100),</b> 40.00 EUR + VAT.</p> <p><b>Circular wall block (250x50),</b> 30.00 EUR + VAT.</p>

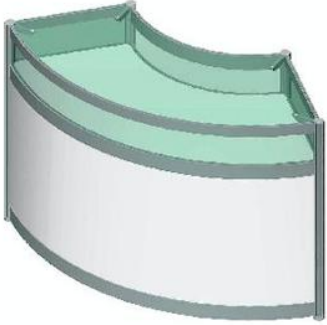
 <p><b>C</b> <b>D</b></p>	 <p><b>D</b> <b>E</b></p>	 <p><b>C</b> <b>F</b></p>
<p><b>Example: equipped corner stand with cornice, information counter (C) and built-in shelf for TV (D).</b></p>	<p><b>Example: equipped stand with a built-in shelf TV (D) and showcase (100x50x250) with glass (E).</b></p>	<p><b>Example: equipped corner stand with 2 information counters (C) and table showcase (100x100x100) (F).</b></p>

 <p><b>C</b></p>		
<p><b>Information counter</b> (100x50x100), with one shelf and non-lockable sliding door, 56.00 EUR + VAT.</p> <p><b>Printing on the front panel of the information counter with removable adhesive vinyl.</b>          €65.00 + VAT per surface with a client-prepared print file (price includes printing, application, and removal after the exhibition, but design services are not included).</p>	<p><b>Information counter</b> (50 x 50, h=100), 41.00 EUR + VAT.</p>	<p><b>Curved information counter</b> (50x100, r=100, h=100), 66.00 EUR + PVN.</p> <p><b>Printing on the front panel of the information counter with removable adhesive vinyl.</b>          €65.00 + VAT per surface with a client-prepared print file (price includes printing, application, and removal after the exhibition, but design services are not included).</p>

		 <p><b>F</b></p>
<p><b>Curved table showcase</b> (50x100x100, r=100), height of the glazed part 20 cm, 76.00 EUR + VAT.</p>	<p><b>Table showcase</b> (50x50x100), height of the glazed part 20 cm, 51.00 EUR + VAT.</p>	<p><b>Table showcase</b> (100x100x100), height of the glazed part 20 cm, 71.00 EUR + VAT.</p>

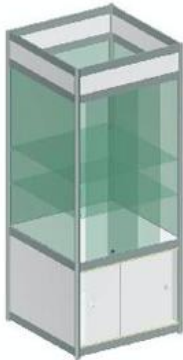
	 <p><b>E</b></p>	
<p><b>Showcase with 2 shelves and glass</b> (50x50x250), 81.00 EUR + VAT.</p>	<p><b>Lockable showcase with 2 shelves and glass</b> (100x50x250), 96.00 EUR + VAT.</p>	<p><b>Lockable showcase with 2 shelves and glass</b> (100x100x250), 106.00 EUR + VAT.</p>



**Showcase with 2 shelves without glass** (50x50x250), 66 EUR + VAT.



**Showcase with 2 shelves without glass** (50x100x250), 76.00 EUR + VAT.

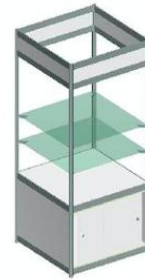

**Showcase with 2 shelves without glass** (100x100x250), 81.00 EUR + VAT.



**Podium** (100x100, h=30), 31.00 EUR + VAT. (without side filling, max 30kg)



**Podium** (500x100, h=30), 26.00 EUR + VAT. (without side filling, max 30kg)



**Coffee table** (60x100 cm, h=42), 76.00 EUR + VAT.



**Swing-up brochure holder** (grey) (A4, 5 positions, h=155 cm), 46.00 EUR + VAT.



**Swing-up brochure holder** (black) (A4, 5 positions, h=155 cm), 46.00 EUR + VAT.



**Brochure holder**(A4x5 positions), Metal, grey. Fastened to wall structures.. 8.00 EUR + VAT.



**Built-in clothes hanger** (h = optional, wall-block is not included in the price), 26.00 EUR + VAT.



**Lighting lamp in a stem (100 W) outside the cornice** 21.00 EUR + VAT



**Additional (standard) lighting (LED, 10W), suitable for indoor use, 14.00 EUR + VAT**

## #2.5: Visually effective solutions with simple technical setup.



**#2.5.1. Curved information counter (50×100 cm, r=100cm, h=100cm), integrated with the cornice to form a curved stand corner - 80.00 EUR + VAT (price includes the counter and assembly together with the fascia)**

*Optional design add-on:*

*Front panel branding with removable adhesive vinyl - 65.00 EUR + VAT (one surface, based on client-supplied print-ready file). Price includes printing, application, and removal. Design/layout services are not included.*

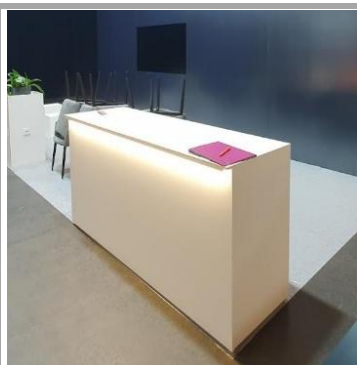

**# 2.5.2. Furnished counter with LED lighting and lockable doors (200x50cm, h=100cm) - 125.00 EUR + VAT.**

*Optional design add-ons (design/layout not included):*

- *Full-colour front panel wrap (based on client-supplied print-ready file) - 75.00 EUR + VAT.*
- *Single-colour front panel wrap using client file - 67.00 EUR + VAT.*
- *Plotter-cut vinyl graphic based on client file - 75.00 EUR/m<sup>2</sup> + VAT.*



**# 2.5.3. Furnished counter with LED lighting and lockable doors (100x50cm, h=100cm) - 75.00 EUR + VAT.**





















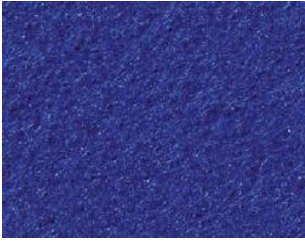
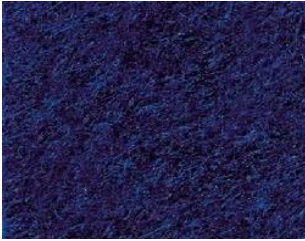

*Optional design add-ons (design/layout not included):*

- *Full-colour front panel wrap (based on client-supplied print-ready file) - 41.00 EUR + VAT.*
- *Single-colour front panel wrap using client file - 37.00 EUR + VAT.*
- *Plotter-cut vinyl graphic based on client file - 38.00 EUR/m<sup>2</sup> + VAT.*

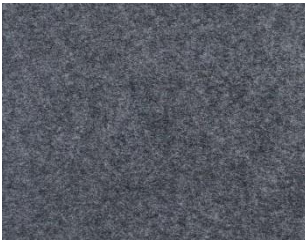

## #2.6: Laying a coloured carpet in stand.

- Laying of grey carpet (*without a protective film*) in non-equipped stands, 7.00 EUR / sq.m + VAT.
- Laying of coloured carpet (*ticker and with a protective film*), 9.00 EUR / sq.m + VAT.
- *For built-up areas* – replacement of gray carpet with colored carpet, €4.00/sq.m + VAT.

The table below summarizes the available colours. **Important:** Actual colours may vary, due to different device screen settings. Samples of carpets are available at the Exhibition office!

4058 PURPER 	3456 FUCHSIA 	3307 OPERA RED 	3037 FIRE 
3039 VERMILJOEN 	3032 CERISE 	4033 FLAMME 	4680 SAFRAN 
4321 YELLOW 	6063 GEELGROEN 	6432 FOREST 	6065 BR GREEN 
6064 VERT BOUTEIL 	5054 BLAUW 	5055 HELBLAUW 	5543 BLUE 
2294 LT GREY 	2022 LT GREY 	2024 GRIJS 	2020 MIX GREY 
2021 BLACK 	1005 WHITE 	1017 LAMA 	1234 SAND 

## #2.7: Stand panel branding and cladding options in the hall

		
<p><b>Print on wall panels in the exhibition area using removable adhesive vinyl.</b></p> <p>€65.00 + VAT per column with a client-prepared print file (price includes printing, application, and removal after the exhibition, but design services are not included).</p>	<p><b>Cladding of structural framework in the exhibition area with printed panels</b> (seamless wall without visible connection points).</p> <p>€95.00 + VAT per column with a client-prepared print file (price includes printing, installation, and removal after the exhibition, but design services are not included).</p>	<p><b>Design services.</b></p> <p>€25.00 + VAT per hour.</p>

## #2.8: Custom non-standard solutions – technically complex individual options.

To make your stand more visually attractive and more effective in drawing visitor attention, we recommend considering creative, non-standard stand design solutions. **Below are a few examples for inspiration.**

If this approach interests you, please contact us (the Exhibition Office) to discuss your ideas, requirements, technical options, and budget. **In cooperation with our partners, we can develop and implement customized solutions** - from simple enhancements to fully unique constructions.

**Total costs are calculated individually, as they depend on several factors**, including size, type and number of suspension or mounting points (ceiling or stand-mounted), printing solution (single-colour or full-colour), materials, and other technical parameters.



### Lighting truss structures in various sizes and configurations for stand illumination.

The solution allows the lighting to be adapted to the stand size and layout, ensuring strong visibility and visual impact.

Includes: truss structure rental, installation and dismantling, suspension points, transport, and spotlights for stand lighting.



**Elevated stand header above exhibition walls with custom signage** (above 2.5 m height), available in various dimensions.

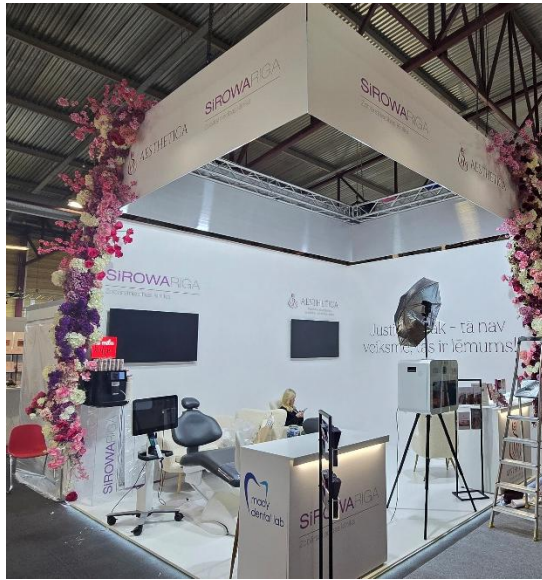

**Stand branding with a wrapped polycarbonate panel mounted on a truss structure.**

Typically installed in the center of the stand or around its perimeter, but partial solutions are also possible — for example, branding only the central section of the stand. This element effectively highlights the stand location in the hall and improves visibility from a distance. The solution includes: truss structure rental and installation, suspension points, transport, and spotlights for stand illumination.



**Stand branding with PVC banners mounted on a truss structure around the stand perimeter.**

A more cost-effective solution compared to polycarbonate panels. After the exhibition, the banners can be carefully removed and stored (rolled onto a core) for repeated use at future exhibitions. The solution includes: rental of structural elements, banner printing, installation and dismantling, and transport.



**Branded lightboxes** (sizes from 200 × 100 cm up to 500 × 100 cm) - includes element rental, printed graphics, transport, and installation, suspended from the ceiling using designated suspension points.

## Ideas for custom stand design solutions tailored to your brand:



More detailed info about the ordering process is available also on [www.ramava.lv](http://www.ramava.lv) (here: [Participation terms](#))

**To apply for additional services and to rent equipment or furniture, please send us an email with a list of the services and equipment items you are interested in: [izstade@ramava.lv](mailto:izstade@ramava.lv)**

**We will be happy to answer your questions!**

**Exhibition Office (A.M.L. SIA, Business Centre RĀMAVA, hall building, 1st floor next to INFO point)**

E-mail: [izstade@ramava.lv](mailto:izstade@ramava.lv)  
Phone: +371 67600409