



34. tehnisko nozaru biznesa izstāde

**BILTIM
TEHNIKA'25**

Informative material and pricelist

Rent of additional equipment and furniture and examples of standardised equipped-stand



This file contains information about the most frequently rented furniture and equipment. If you do not find what you are looking for, please contact us and, possibly, we may be able to help.

1. Two visual examples of equipped area in the hall. Furnishing of the stand is up to you.





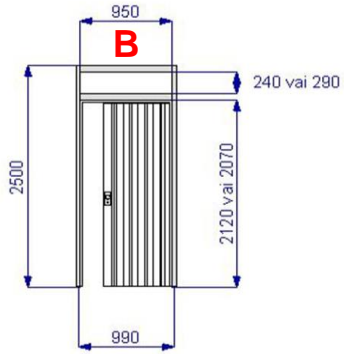

<p style="text-align: right;">3x5m</p>	<p style="text-align: right;">3x3m</p>	
<p>Equipped stand with 2 open sides</p> <p><i>15 sq.m. (5 m wide; 3 m deep). Standard construction performed by the organizer – grey carpet (15 sq.m), standard walls and creation of stand constructions (8 m) and cornice (8 m), provision of stand lighting (5 pcs.) and electrical connection (220V, up to 2kW) with socket.</i></p>	<p>Equipped stand with 1 open sides</p> <p><i>9 sq.m (3 m wide; 3 m deep). Standard construction performed by the organizer – grey carpet (9 sq.m), standard walls and creation of stand constructions (9 m) and cornice (3 m), provision of stand lighting (3 pcs.) and electrical connection (220V, līdz 2kW) with socket.</i></p>	<p>Wall construction parameters.</p> <p><i>Height of white panels with construction - 2,500 mm Visible white part: 950 mm The total size of the panel and construction - 1030 mm.</i></p>

<p>Print on wall panels in the exhibition area using removable adhesive vinyl.</p> <p>€65.00 + VAT per column with a client-prepared print file (price includes printing, application, and removal after the exhibition, but design services are not included).</p>	<p>Cladding of structural framework in the exhibition area with printed panels (seamless wall without visible connection points).</p> <p>€95.00 + VAT per column with a client-prepared print file (price includes printing, installation, and removal after the exhibition, but design services are not included).</p>	<p>Design services.</p> <p>€25.00 + VAT per hour.</p>

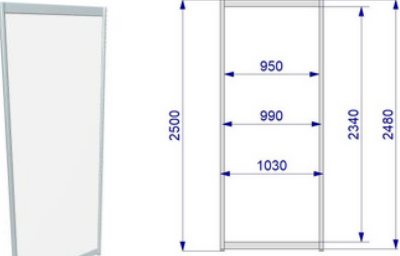
2. Construction of a lockable room in the stand. Example with room of 1x1m

		
<p>Above you can see a room with area of 1x1m. It is made from 1 standard wall panel and 1 block with sliding doors. The area (size) and configuration of the lockable room can be adapted to your needs!</p> <p>A) Wall panel (250x100) (including the construction of the frame structure) – 26.00 EUR + VAT. B) Sliding door block (including frame construction) – 41.00 EUR + VAT.</p>		

3. Examples of additional equipment furniture offered for rent.

		
<p>A</p> <p>Wall panel (250x100) (including the construction of the frame structure), 26.00 EUR + VAT.</p> <p>Wall panel (250x50) (including the construction of the frame structure), 20.00 EUR + VAT.</p>	<p>Mounting of one wall-block constructions (without panel), 21.00 EUR + VAT.</p>	<p>B</p> <p>Wall-block with sliding doors (including mounting of panel constructions), 41.00 EUR + VAT.</p> <p>Wall-block with hinged doors (including mounting of panel constructions), 56.00 EUR + VAT.</p>
		
<p>Built-in shelf, for example for placing TV, (100x30x120), 30.00 EUR + VAT. (h=120, max 30kg, wall-block is not included in the price).</p>	<p>Built-in shelf (30x100), 15.00 EUR + VAT (per 1 shelf, h = optional, max 10kg, wall-block is not included in the price).</p>	<p>Circular wall block (250x100), 40.00 EUR + VAT.</p> <p>Circular wall block (250x50), 30.00 EUR + VAT.</p>

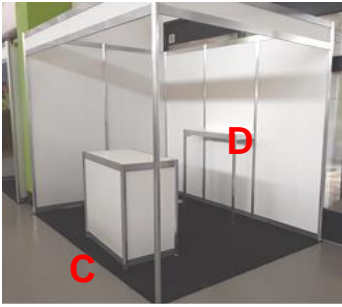

Example: equipped corner stand with cornice, information counter (C) and built-in shelf for TV (D).



Example: equipped stand with a built-in shelf TV (D) and showcase (100x50x250) with glass (E).



Example: equipped corner stand with 2 information counters (C) and table showcase (100x100x100) (F).



Information counter (100x50x100), with one shelf and non-lockable sliding door, 56.00 EUR + VAT.

Printing on the front panel of the information counter with removable adhesive vinyl.

€65.00 + VAT per surface with a client-prepared print file (price includes printing, application, and removal after the exhibition, but design services are not included).



Information counter (50 x 50, h=100), 41.00 EUR + VAT.



Curved information counter (50x100, r=100, h=100), 66.00 EUR + PVN.

Printing on the front panel of the information counter with removable adhesive vinyl.

€65.00 + VAT per surface with a client-prepared print file (price includes printing, application, and removal after the exhibition, but design services are not included).

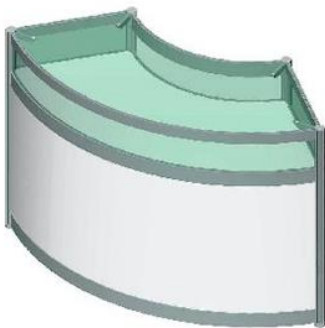

Curved table showcase (50x100x100, r=100), height of the glazed part 20 cm, 76.00 EUR + VAT.



Table showcase (50x50x100), height of the glazed part 20 cm, 51.00 EUR + VAT.

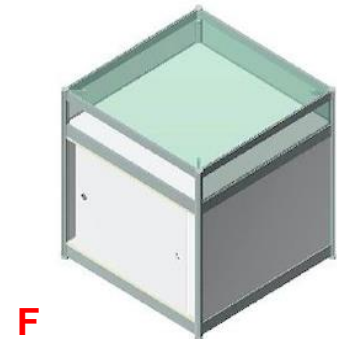

F

Table showcase (100x100x100), height of the glazed part 20 cm, 71.00 EUR + VAT.



Showcase with 2 shelves and glass
(50x50x250), 81.00 EUR + VAT.

E



Lockable showcase with 2 shelves and glass (100x50x250), 96.00 EUR + VAT.

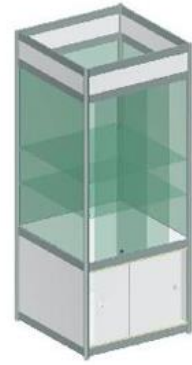

Lockable showcase with 2 shelves and glass (100x100x250), 106.00 EUR + VAT.



Showcase with 2 shelves without glass
(50x50x250), 66 EUR + VAT.



Showcase with 2 shelves without glass (50x100x250), 76.00 EUR + VAT.

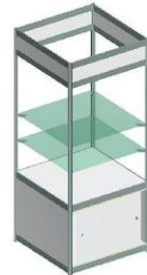

Showcase with 2 shelves without glass (100x100x250), 81.00 EUR + VAT.



Podium (100x100, h=30), 31.00 EUR + VAT.
(without side filling, max 30kg)



Podium (500x100, h=30), 26.00 EUR + VAT.
(without side filling, max 30kg)



Coffee table (60x100 cm, h=42), 76.00 EUR + VAT.



Swing-up brochure holder (grey) (A4, 5 positions, h=155 cm), 46.00 EUR + VAT.



Swing-up brochure holder (black) (A4, 5 positions, h=155 cm), 46.00 EUR + VAT.



Brochure holder(A4x5 positions), Metal, grey. Fastened to wall structures.. 8.00 EUR + VAT.



Clothes hanger stand, (h=203 cm), 31.00 EUR + VAT.



Built-in clothes hanger (h = optional, wall-block is not included in the price), 26.00 EUR + VAT.



Additional (standard) lighting (LED, 10W), suitable for indoor use, 14.00 EUR + VAT.

4. Tables and chairs available for rent.



Small round table (d =81.3, h=74.3cm, light grey) – 11.00 EUR + VAT.

Tablecloth for round table (d=210 cm, white) – 15.00 EUR + VAT.



Large round table (d=122, h=74.3cm, light grey) – 12.00 EUR + VAT.

Tablecloth for round table (d=210 cm, white) – 15.00 EUR + VAT.



Squared table (182.9x75.2, h=74.3cm, light grey) – 13.00 EUR + VAT.

Tablecloth (154x245cm, white) – 15.00 EUR + VAT.



Bar type table (d=81.3, h=110 cm, light grey) – 13.00 EUR + VAT.

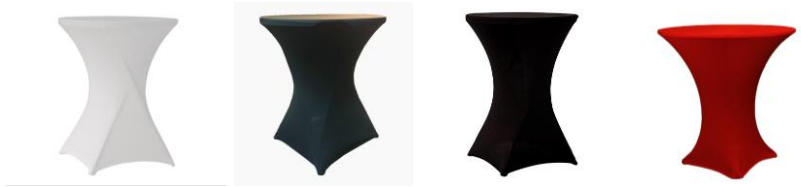

Elastic tablecloth for bar type table: white, grey, black or red –15.00 EUR + VAT.



Table (80x80cm, h=75 cm.). 56.00 EUR + VAT.



Bar type chair (35x35, h=94cm, white, black or dark gray surface), 26.00 EUR + VAT.



Banquet type chair (38x40, h =96cm, white surface), 26.00 EUR + VAT.



Folding chair (47x55.6, h=84cm, light grey), 6.00 EUR + VAT.



Banquet type chair (44x46, h=93cm, black with brown dots), 8.00 EUR + VAT.



Bar type chair (35x35, h=94cm, black surface), 9.00 EUR + VAT.

5. Custom Solution Options.

To make your exhibition stand visually more attractive and draw more attention from visitors, we recommend considering unique, custom solutions for your stand setup. Below are images of a few examples.

If interested, please contact us (Exhibition Office) to discuss your preferences and needs in detail. This will help us provide suitable solutions tailored to your requirements. For custom solutions, we collaborate with our partner Parrot Telpa, who can bring nearly any idea to life!



6. Laying a coloured carpet in stand.

Laying of grey carpet (*without* a protective film) in non-equipped stands, 7.00 EUR / sq.m + VAT.

Laying of coloured carpet (*ticker and with* a protective film), 9.00 EUR / sq.m + VAT.

* For built-up areas – replacement of gray carpet with colored carpet, €4.00/sq.m + VAT.

→ The table below summarizes the available colours. *Important:* Actual colours may vary, due to different device screen settings. Samples of carpets are available at the Exhibition office!

4058 PURPER



3456 FUCHSIA



3307 OPERA RED



3037 FIRE



3039 VERMILJOEN

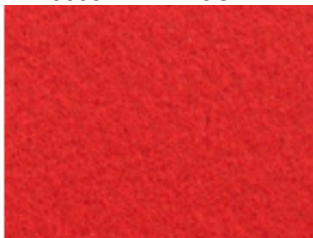

3032 CERISE



4033 FLAMME



4680 SAFRAN



4321 YELLOW



6063 GEELGROEN



6432 FOREST



6065 BR GREEN

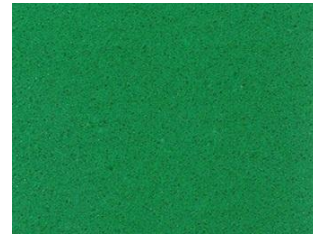

6064 VERT BOUTEIL



5054 BLAUW



5055 HELBLAUW



5543 BLUE



2294 LT GREY



2022 LT GREY



2024 GRIJS



2020 MIX GREY



2021 BLACK



1005 WHITE



1017 LAMA



1234 SAND



In order to apply for additional services and order equipment and furniture, please send a list of additional services and furniture you are interested to rent to our e-mail address izstade@ramava.lv.

More detailed information about the ordering process is available also in the [Participation terms](#).

We will be happy to answer to your questions!

Exhibition office (A.M.L. SIA)

E-mail: izstade@ramava.lv

Phone: +371 67600409

Business centre RĀMAVA (hall, 1st floor)

Homepage: www.ramava.lv

